



Open Access : : ISSN 1847-9286

<https://pub.iapchem.org/ojs/index.php/JESE>

Original scientific paper

Wastewater treatment by multi-stage batch adsorption and electrochemical regeneration

FADHIL M. MOHAMMED[‡], EDWARD P. L. ROBERTS[✉], ANDREW K. CAMPEN* and NIGEL W. BROWN*

School of Chemical Engineering and Analytical Science, University of Manchester. The Mill, Oxford Road, Manchester M13 9PL, UK; [‡]Current address: Ministry of Science and Technology, Baghdad, Iraq

*Arvia Technology Ltd, Daresbury Innovation Centre, Keckwick Lane, Daresbury, Cheshire WA4 4FS, UK.

✉ Corresponding Author: E-mail: edward.roberts@manchester.ac.uk; Tel.: +44-161-306-8849; Fax: +44-161-306-9321

Received: May 23, 2012; Revised: August 18, 2012; Published: November 10, 2012

Abstract

The removal and destruction of a tri-phenyl methane dye, Acid Violet 17 (AV17), from aqueous solution by adsorption and electrochemical regeneration was studied using a graphite intercalation compound (GIC) adsorbent. It was demonstrated that the adsorbent could be regenerated by anodic oxidation of the adsorbed dye in a simple electrochemical cell. The GIC adsorbent recovered its initial adsorption capacity after 40 to 60 min of treatment at a current density of 10 mA cm^{-2} , corresponding to a charge of 12 to 18 C g^{-1} of adsorbent. The charge passed is consistent with that expected for mineralisation of the dye, suggesting that the dye was removed and destroyed with high charge efficiency. The energy cost of the regeneration was found to be around 120 J per g of adsorbent regenerated or 115 J per mg of the AV17 dye removed and destroyed. A model describing the process of wastewater treatment by multiple cycles of adsorption and electrochemical regeneration, based on adsorption isotherm data, has been developed and validated. It was found that relatively modest improvements in the adsorption capacity of the adsorbent material could significantly improve the process performance.

Keywords

Adsorption; electrochemical regeneration; graphite intercalation compound; tri-phenyl methane dye; acid violet.

Introduction

Dyestuff removal has been one of the most persistent problems in wastewater treatment in the last thirty years. Recent methods which have been investigated for dye removal include adsorp-

tion, ion exchange, chemical oxidation, precipitation and biological treatment [1,2]. There are ever more dyes available commercially, and due to their complex structure and synthetic origin, most are difficult to decolorize [3]. Therefore, it is necessary to remove them from liquid wastes at least to a limit accepted by national and international regulatory agencies before discharge. Adsorption is a widely used technique for the removal of dyes from wastewater and can be effective for overall treatment, particularly if the sorbent is cheap, does not require a pre-treatment step before application and is easy to regenerate [4]. Adsorption on activated carbon is a technology which has been widely studied to remove dyes from wastewater but the high capital and regeneration cost of activated carbon has led to the search for low cost materials. In the last twenty years, many investigators have studied the feasibility of inexpensive, commercially available materials, that are easy to regenerate and re-utilized as many times as possible [5]. In recent years many inexpensive, widely available materials have been investigated as adsorbents to remove dyes from contaminated water. Wood, fly ash, coal, zeolite, silica, and agricultural wastes have all been tried with varying degrees of success [6-14].

The adsorption of dyes from aqueous solutions onto these inexpensive adsorbent materials focused on the determination of the capacity, kinetics, equilibrium isotherms and the effect of different parameters such as thermodynamics, pH, bonding mechanisms, and desorption [14-16]. However, only limited application of such data has been directed to the modelling of the batch adsorption / regeneration process for wastewater treatment.

Electrochemical regeneration of activated carbon adsorbents was demonstrated by Narbaitz and Cen in 1994 [17] and there have been several recent studies of this process [18-20]. However, the process is not economic as regeneration is slow and the energy cost is high [21], due to the poor conductivity of the activated carbon bed. Recent work has shown the potential of graphite intercalation compound (GIC) adsorbent materials that can be electrochemically regenerated very rapidly and cheaply [21-24].

Conventional adsorption processes are designed based on the single use of a batch of adsorbent. The rapid electrochemical regeneration process discussed above opens up the possibility of using a batch of adsorbent for multiple cycles of adsorption with regeneration carried out on-site. In this way the adsorbent can be reused many times. In addition, a treatment process can be envisaged where the water is treated by the same batch of adsorbent through several cycles of adsorption and regeneration. This approach has been used to treat radioactive organic waste in the nuclear industry [25]. In this study we aim to carry out the first detailed study of this multi-stage adsorption and electrochemical regeneration process.

Experimental

Materials

The adsorbate used in this study was Acid Violet 17, a powdered, anionic tri-phenyl methane dye, which has three substituent groups and is a mono sodium salt. It was supplied by KEMTEX Educational Supplies Ltd under the trade name Kenanthrol Violet 2B at a dye content of about 22 %. Analysis is by UV/Vis spectroscopy at a λ_{\max} of 542 nm, as described in our earlier paper [26]. The adsorbent used was a graphite intercalated compound (GIC), NyexTM 1000, supplied by Arvia Technology Ltd., which contains around 94 wt. % carbon and has a particle size range of 100 – 700 μm [26].

Adsorption/electrochemical regeneration methodology

A laboratory scale sequential batch rig (see Fig. 1) was used for both adsorption and electrochemical regeneration, which were carried out at the ambient laboratory temperature of 20°C. In each experiment 100 g of GIC adsorbent was mixed with 1 L of water in the adsorption zone by sparging air into the bottom of the rig.

After adsorption, the adsorbent was allowed to settle into the anodic compartment of the electrochemical regeneration zone. The adsorbent bed was in contact with a graphite anode and was separated from the perforated stainless steel cathode (316L with open area 33%, 3 mm holes) by a microporous polyethylene separator (Daramic 350, Grace GmbH). The separator acts as a barrier to minimize the transport of electrolyte through the membrane and to ensure that the GIC bed does not contact the cathode, as this would short circuit the electrochemical cell. The cathode compartment was filled with 0.3 wt% NaCl solution to provide good conductivity, and the pH of this solution was adjusted to below 2 using hydrochloric acid to ensure that the membrane was stable. The anode, cathode and membrane of the electrochemical cell had dimensions of 10 cm by 7 cm, and the gap between the anode current feeder and the membrane was 2.2 cm. The 100 g of adsorbent used formed a bed of depth 5 cm in the anode compartment. A DC power supply was used to apply a current of 0.5 A to the cell, corresponding to a current density (from studies by Brown, 2005) of 10 mA cm⁻² (based on the membrane area).

Ideally electrochemical regeneration should occur throughout the bed depth in the anode compartment. Although it is difficult to measure the current distribution in the packed bed electrode, previous studies with GIC adsorbents have examined the effect of bed thickness [22] or separated and tested layers of adsorbent in the regeneration bed [24]. These studies have indicated that complete regeneration can be achieved with bed depths of up to around 20 mm.

Prior to each experiment 100 g of fresh adsorbent was mixed with 1 litre of clean water for 30 min before being allowed to settle into the electrochemical regeneration cell. The water was drained off and a current of 0.5 A was applied for 30 min in order to oxidise any organic impurities present on the surface of the adsorbent. A volume of 1 L of solution containing 120 mg L⁻¹ of AV17 was then added to the cell. This concentration was selected in order to saturate the adsorbent and to give a significant equilibrium concentration. This was necessary to ensure that the equilibrium concentration achieved with the regenerated adsorbent can be accurately measured.

The adsorbent and AV17 solution were mixed by sparging air into the cell for 120 min. This adsorption time was found to be sufficient to ensure that equilibrium was reached at these conditions. Once the adsorption stage was complete, the air was switched off and the adsorbent particles settled into the anodic compartment of the electrochemical cell. The treated liquid was drained off and a sample was taken and analysed by UV/visible spectroscopy in order to determine the loading of AV17 dye on the adsorbent.

The bed was regenerated for a period of between 10 and 120 min. After regeneration the supernatant was drained from above the bed of GIC adsorbent and the adsorption stage was repeated using a fresh AV17 solution (120 mg L⁻¹) which was added to the cell. The adsorption stage was repeated by sparging with air for a period of 120 min. A sample of the solution obtained after adsorption was analysed by UV/vis spectroscopy, as described above. The performance of the regeneration was characterised using the 'regeneration efficiency', obtained by comparing the equilibrium adsorbent loading achieved before and after regeneration:

$$\eta_r / \% = \frac{q_r}{q_i} \times 100 \quad (1)$$

where q_i and q_r are the equilibrium loading (q_e) of AV17 on the adsorbent (mg g^{-1}) obtained before and after regeneration, respectively, calculated using Equation (2).

$$q_e = \frac{V(C_0 - C_e)}{W} \tag{2}$$

where C_0 and C_e are the initial and equilibrium concentration of AV17 in solution respectively (mg L^{-1}), V is the volume of solution (L), and W is the mass of adsorbent used (g).

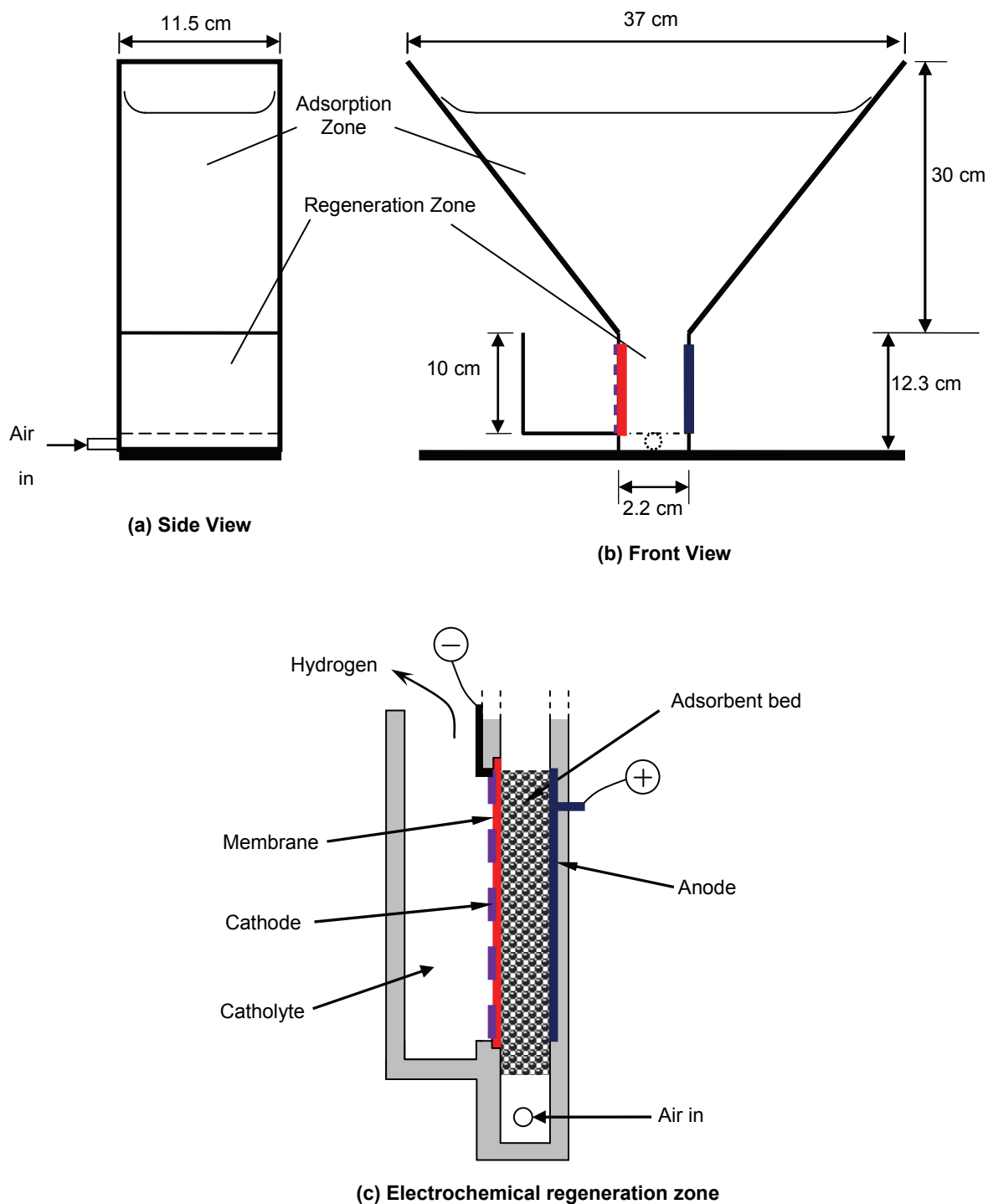

Figure 1. Laboratory scale sequential batch rig for electrochemical regeneration of the GIC adsorbent: schematic diagram of the side (a) and front (b) elevation of the rig, and (c) schematic diagram showing a cross section of the electrochemical regeneration zone.

A similar technique was used for multi-stage batch adsorption and electrochemical regeneration, but in this case the solution was not drained off after the adsorption cycle. In this case, the initial concentration of AV 17 was much higher, 668 mg L^{-1} as this solution was treated by a series of adsorption/regeneration cycles. For these experiments, the amount of GIC adsorbent was increased to 125 g, which formed a bed of 7 cm depth in the anode compartment. In addition, the adsorption time was reduced to 60 min and the regeneration time was 30 min.

Results and Discussion

Adsorption isotherm

The design of a batch adsorber system requires knowledge of the equilibrium isotherm to understand the adsorption process behaviour and provide fundamental physiochemical data for evaluating the maximum capacity of the adsorbent [27]. Batch sorption studies have been performed previously to investigate the kinetic and equilibrium isotherm of the adsorption of the Acid violet 17 [26]. The experimental data were found to fit the Langmuir isotherm model, Equation (3).

$$q_e = \frac{bk_L C_e}{1 + bC_e} \quad (3)$$

where k_L and b are the Langmuir constants related to the capacity of the adsorbent (mg g^{-1}) and the intensity of adsorption, (L mg^{-1}), respectively.

There is little data available in the literature on the adsorption of AV17 by activated carbon, but there is some data on other dyes such as methylene blue [28]. The comparison of Langmuir isotherm constants for adsorption of organic dye calculated in this work with those determined by [28] for activated carbon are shown in Table 1. The low surface area of the adsorbent leads to a relatively low adsorption capacity, as indicated by the relatively low value of k_L . However, if the adsorptive capacity (k_L) is normalised with the specific surface area, it is found that the GIC adsorbent is able adsorb a higher mass of dye per unit area than the activated carbons studied (albeit for a different adsorbate). This suggests that either the GIC has more adsorption sites per unit area or (more likely) that some of the activated carbon surface area in the micropores and is not accessible to the dye molecules.

Table 1. Comparison of Langmuir constants and surface area for adsorption of methylene blue (MB), and AV17 onto activated carbons [28] and the GIC adsorbent NyexTM 1000 [29], respectively, at room temperature (23°C) and normal pH.

| Adsorbent | Adsorbate | Langmuir constant | | Surface area (BET), $\text{m}^2 \text{g}^{-1}$ | Adsorptive capacity, mg m^{-2} |
|-------------------------------|-----------|--------------------------|------------------------|--|---|
| | | $k_L / \text{mg g}^{-1}$ | $b / \text{L mg}^{-1}$ | | |
| GIC (Nyex TM 1000) | AV17 | 0.987 | 0.31 | 1.0 | 0.987 |
| Activated carbon (PAC1) | MB | 307 | 0.12 | 863.50 | 0.36 |
| Activated carbon (PAC2) | MB | 345 | 0.15 | 857.14 | 0.4 |
| Activated carbon (F400) | MB | 455 | 0.2 | 1216.4 | 0.37 |

The essential characteristic of the Langmuir isotherm shape on whether adsorption is 'favourable' or 'unfavourable' can be classified in terms of dimensionless separation factor or equilibrium parameter, R_L , Equation (4) [30].

$$R_L = \frac{1}{1 + bC_{mx}} \tag{4}$$

where C_{mx} is the maximum solution concentration studied. The separation factor R_L indicates the isotherm shape according to Table 2.

Table 2. Effect of separation factor on isotherm shape [30].

| Value of R_L | Type of isotherm |
|----------------|------------------|
| $R_L > 1$ | Unfavourable |
| $R_L = 1$ | Linear |
| $0 < R_L < 1$ | Favourable |
| $R_L = 0$ | Irreversible |

The separation factor for the GIC adsorbent ($b = 0.31 \text{ L mg}^{-1}$) has been calculated at range of maximum concentrations of AV17 as shown in Figure 2. It can be observed from this figure that the value of R_L lies between 0 and 1 at all initial dye concentrations, confirming the favorable uptake of the AV17 by the GIC adsorbent.

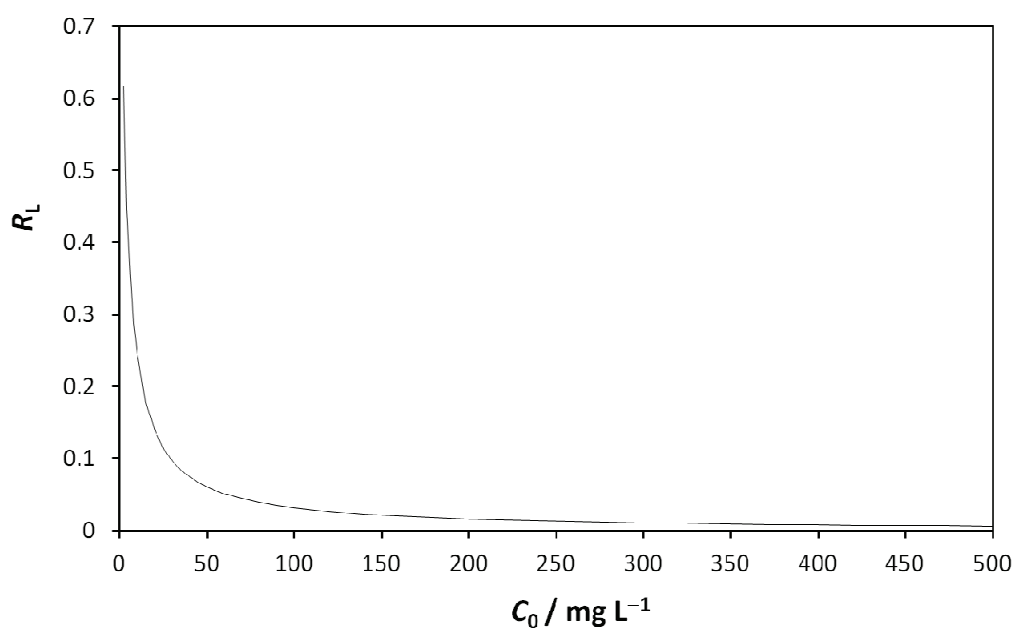

Figure 2. Separation factor for Acid Violet 17 onto the GIC adsorbent Nyex™ 1000 at 20°C.

Using the Langmuir model to determine the solid phase loading q_{mx} in equilibrium with C_{mx} :

$$q_{mx} = \frac{bk_L C_{mx}}{1 + bC_{mx}} \tag{5}$$

Thus:

$$\frac{q_e}{q_{mx}} = \frac{C_e}{C_{mx}} \frac{1 + bC_{mx}}{1 + bC_e} \tag{6}$$

Defining a dimensionless solid phase concentration as $q = (q_e/q_{mx})$, and a dimensionless liquid phase concentration as $C = (C_e/C_{mx})$, we obtain:

$$q = \frac{C}{R_L + (1 - R_L)C} \quad (7)$$

Measured values of q for a range of values of C are plotted in Figure 3, where the maximum equilibrium concentration was $C_{\text{mx}} = 46 \text{ mg L}^{-1}$. The experimental data was fitted to Equation (7) by finding the value of R_L that gave a minimum in the sum of the absolute error (SAE) between the (q, C) data and Equation (7), indicating a value of $R_L = 0.065$. Similar results have been reported for separation factors for the adsorption of the dye AV17 onto activated carbon prepared from sunflower seed hull [16] and orange peel [14].

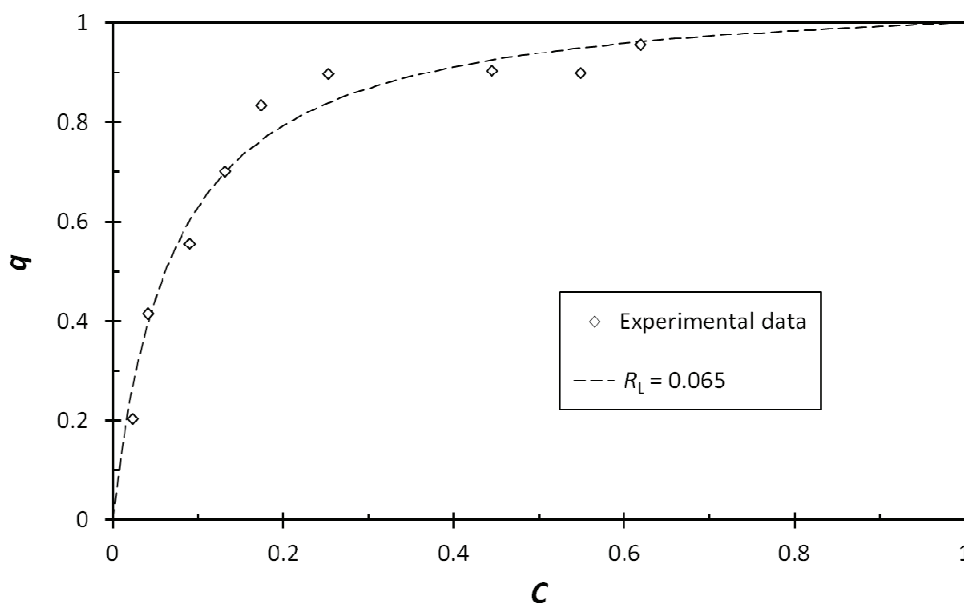

Figure 3. Isotherm shape for adsorption of AV17 onto the GIC adsorbent Nyex™ 1000 at room temperature (23°C) and the curve obtained using Equation (7) with $R_L = 0.065$.

Adsorption and electrochemical regeneration

The liquid phase concentration of AV17 dye after adsorption was found to be in the range 13.2 to 15.4 mg L^{-1} , corresponding to a loading of AV17 on the GIC adsorbent of 1.07 to 1.05 mg g^{-1} . This was slightly higher than the value of k_L (0.987 mg g^{-1}) from the Langmuir adsorption isotherm [29], possibly due to natural variability of the adsorbent, attrition or surface modification of the adsorbent during the washing procedure.

It was found that the full adsorption capacity could be recovered after 40 min of electrochemical regeneration, corresponding to a charge passed of 12 C g^{-1} (Figure 4). Further increases in the regeneration time led to an increase in the adsorption capacity to a value around 10 % higher than the original capacity. There are a number of possible reasons for this increase in adsorption capacity after regeneration. Previous studies [24] have suggested that the electrochemical regeneration can lead to a slight roughening of the adsorbent surface, and thus an increase in the specific surface area available for adsorption. Another possibility is the presence of oxidising species formed in the adsorbent bed during regeneration which may react with the organic dye leading to an apparent increase in adsorption capacity.

For regeneration times less than 40 min, the full capacity of the adsorbent was not recovered. This suggests that some AV17 or its breakdown products remained adsorbed on the surface of the GIC adsorbent. When the full adsorption capacity is recovered, the AV17 dye is either fully minera-

lised, or breakdown products are formed which do not adsorb on the adsorbent and are thus released into the water. Chemical oxygen demand (COD) analysis of treated water (unpublished data from Arvia Technology Ltd) have not found organic breakdown products in solution, suggesting that breakdown products remain adsorbed until full mineralisation is achieved.

It is possible to estimate the charge required to fully mineralise the dye; however this will depend on the products formed. The maximum charge required can be estimated by assuming complete anodic oxidation of the AV17 to carbon dioxide, sulphate and nitrate:

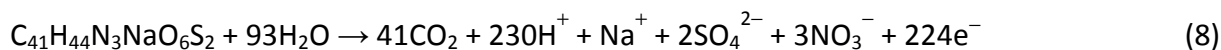

Alternatively a lower estimate of the charge required for mineralisation can be obtained by assuming that the products were carbon monoxide, sulphide and nitrogen:

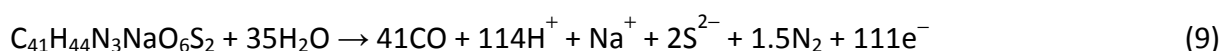

The theoretical charge, Q , for mineralisation of the AV17 dye can be estimated from:

$$Q = \frac{q_e n F}{M_w} \quad (10)$$

where n is the number of electrons required per molecule of dye oxidised, F is Faraday's constant (96487 C mol^{-1}), and M_w is the molecular weight of the dye (761.9 g mol^{-1}). The value of q_e was 1.05 mg g^{-1} , and using $n = 111$ and 224 [based on Equations (4) and (5) respectively] the theoretical charge required for mineralisation of the AV17 would be between 15 and 30 C g^{-1} . Comparison of these values with the data in Fig. 4 suggests that the charge efficiency for the anodic oxidation is high, but further work is needed to determine whether any breakdown products are present in the treated water.

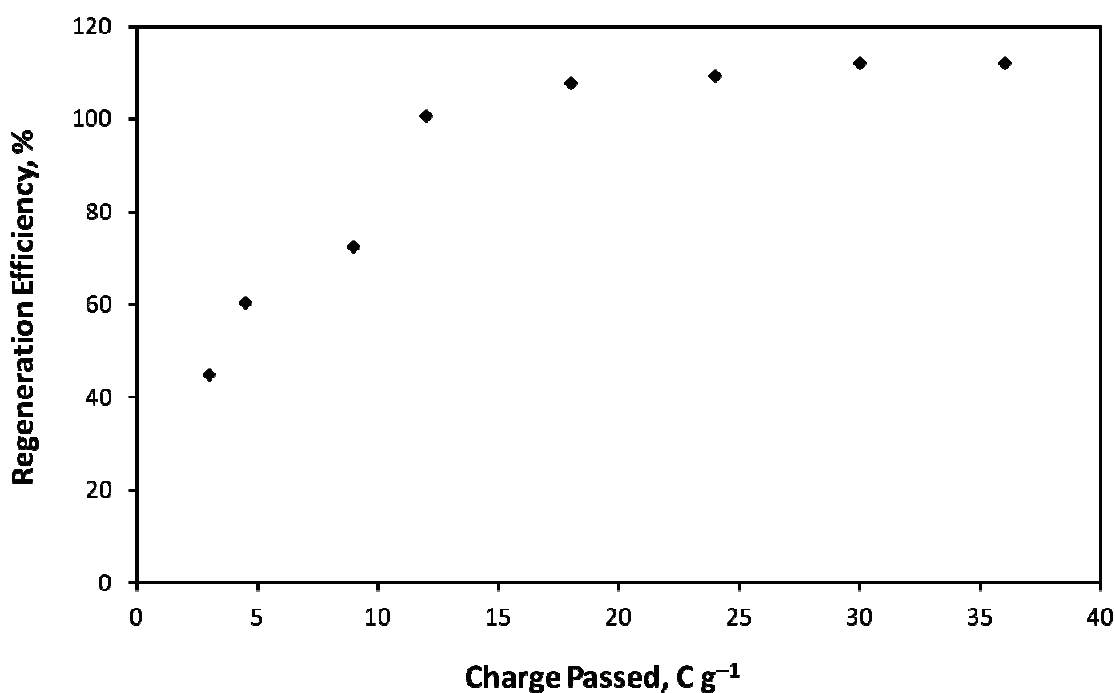

Figure 4. Regeneration efficiency as a function of charge passed during electrochemical regeneration of the GIC adsorbent NyexTM 1000 loaded with 1.06 mg g^{-1} of the organic dye AV17, using a current density of 10 mA cm^{-2} and a bed depth 2.2 cm .

The cell voltage was not continuously monitored, but was observed to be relatively stable at around 6 V throughout regeneration. The cell voltage is dominated by ohmic losses in the membrane and in the water in the anode compartment. Slight variations in the cell voltage were observed, presumably associated with changes in the conductivity of the water in the anode compartment (for example due the decrease in pH caused by the electrochemical processes) or the formation of gas bubbles leading to a decrease in effective conductivity. It was thus not possible to use the cell voltage to determine the completion of the regeneration. Based on a cell voltage of 6 V, the energy cost of the regeneration was 120 J per g of adsorbent regenerated or 115 J per mg of AV17 removed and destroyed.

Multi-stage batch design model

Batch adsorption and regeneration process are usually carried on small volumes of wastewater. However, the efficiency of dye removal can be improved by carrying out the treatment using multi-stage adsorption/regeneration system. An adsorption isotherm can be used to predict the design of a single stage batch adsorption system [31-36]. A wastewater treatment process consisting of a series of adsorption and regeneration stages can be considered to be a multi-stage equilibrium operation. The adsorption isotherm can thus be used to design a multi-stage adsorption / regeneration process as shown in Figure 5.

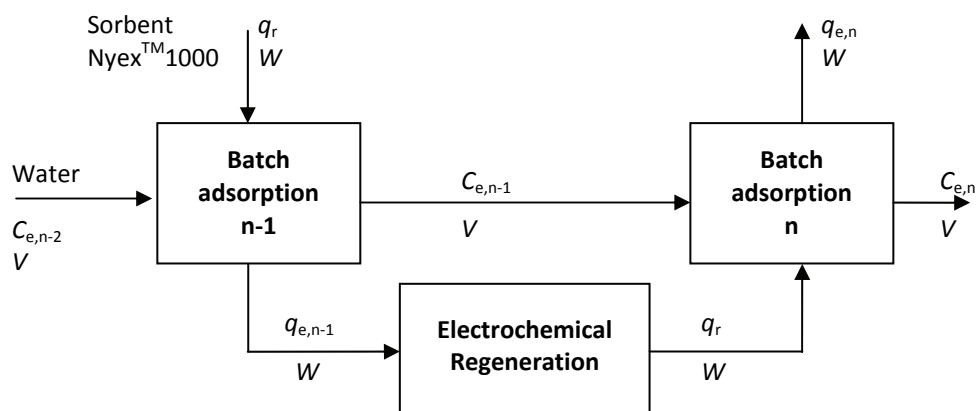

Figure 5. Schematic diagram of two stages in a multi-stage batch adsorption and regeneration system, considered as a multi-stage equilibrium process.

The design objective is to reduce the dye concentration in the feed (of volume V) from C_0 to C_n (mg L^{-1}), reusing the adsorbent (of mass W) in each adsorption stage after regeneration. The dye mass balance for batch adsorber system (n) in Figure 5 can be written as:

$$V C_{e,n-1} + W q_r = V C_{e,n} + W q_{e,n} \quad (11)$$

For the electrochemical regeneration process used in this study, we can assume that the regeneration efficiency was 100% (based on the data shown in Figure 4), so $q_r = q_0 = 0$, and Equation (11) thus becomes:

$$V (C_{e,n-1} - C_{e,n}) = W q_{e,n} \quad (12)$$

The experimental adsorption data were found to fit the Langmuir isotherm model (Equation 3) for adsorption of AV17 on the GIC adsorbent. Thus the Langmuir equation can be used to substitute for $q_{e,n}$, giving:

$$\frac{W}{V} = \frac{(C_{e,n-1} - C_{e,n})}{\left(\frac{bk_L C_{e,n}}{1 + bC_{e,n}} \right)} \tag{13}$$

Equation (13) can be rearranged to a quadratic form and solved to give:

$$C_{e,n} = \frac{-\left(\frac{W}{V}bk_L - bC_{e,n-1} + 1\right) \mp \sqrt{\left(\frac{W}{V}bk_L - bC_{e,n-1} + 1\right)^2 + 4bC_{e,n-1}}}{2b} \tag{14}$$

For the first adsorption cycle ($n = 1$), $C_{e,n-1}$ in Equation (14) is replaced by the initial concentration C_0 .

Equation (14) was used to determine the concentration after each stage of treatment for a given feed concentration C_0 and mass of adsorbent (W) using the Langmuir isotherm constants for the GIC / AV17 system: $b = 0.31 \text{ L mg}^{-1}$ and $k_L = 0.987 \text{ mg g}^{-1}$. For a given feed concentration, number of adsorption stages and required percentage dye removal, the solution was iterated numerically using a forward derivative Newton’s method with a convergence limit of 10^{-4} in order to calculate the amount of adsorbent, W (g), required.

The amount of adsorbent W was estimated for a five stage adsorption regeneration system to achieve AV17 dye removals ranging from 10 to 99 %, for a range of initial concentrations ($55 - 680 \text{ mg L}^{-1}$), and the results obtained are plotted in Figure 6.

The results indicate that the amount of adsorbent required increases linearly with the percentage dye removal, up to removals of around 90 to 95 %. This can be explained by observation that the adsorbent approaches its maximum loading in each of the adsorption cycles, so the amount of dye removed per gram of adsorbent is approximately constant. However, to achieve very high removals the dye concentration in the final adsorption stage will be low, so that the adsorbent used in this stage will not be fully saturated. The amount of adsorbent required thus begins to increase more rapidly as the final concentration decreases towards zero.

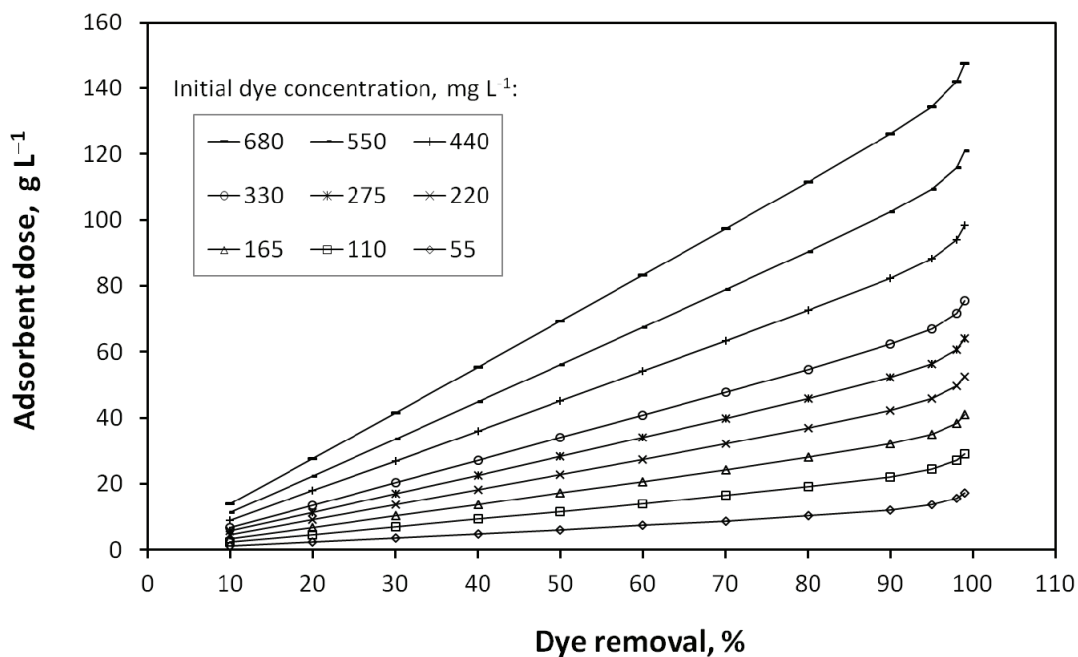

Figure 6. The adsorbent dose required as a function of the dye removal for a range of initial dye concentrations using a five stage batch adsorption and regeneration system.

For validation of the model, an experimental study of a five stage adsorption – regeneration process was carried out for the adsorption of AV17 (with an initial concentration of $C = 668 \text{ mg L}^{-1}$) onto the GIC adsorbent (with an adsorbent dose of 125 g L^{-1}). The values of the percentage removal achieved (R_n) after each stage obtained from the model and the experiment (Equations 14 and 15) were compared, as shown in Figure 7. The percentage removal of AV17 was observed to increase from 19 to 93 % in stages 1 to 5, and there was good agreement between the experimental data and the model. From the experimental data, the adsorbent loading after each adsorption cycle was found to be approximately $1 \pm 0.05 \text{ mg g}^{-1}$, consistent with the capacity of adsorbent obtained from the isotherm study [24]. This confirms that for the conditions used in this experiment the adsorbent was approaching saturation with AV17 after each adsorption cycle.

$$R_n / \% = \frac{C_0 - C_n}{C_0} 100 \quad (15)$$

The adsorbent material investigated in this study has a very low adsorbent capacity, and there is significant potential to develop new adsorbent materials suitable for electrochemical regeneration but with increased adsorptive capacity compared to the GIC adsorbent NyexTM 1000. Recent studies have shown that higher specific surface area adsorbent materials similar to the GIC used in this study can offer improved adsorption capacity [37,38]. In order to evaluate the benefits of increased adsorptive capacity, the effect of the value of the Langmuir k_L on the multi-stage adsorption-regeneration process was investigated. In this case, the number of adsorption/regeneration stages required to achieve 99.9 % AV17 removal (with an initial concentration of 1 g L^{-1}) was calculated for an adsorbent dose of 125 g L^{-1} and for a range of values of k_L (see Figure 8). As k_L was increased, it was found that stage number of stages of adsorption-regeneration required decreased such that a doubling of the adsorbent capacity leads to a reduction in the number of stages required from 10 to 5. A doubling of the adsorbent capacity has been demonstrated [37,38] and an order of magnitude increase in k_L can readily be envisaged, which would reduce the number of stages required to only 2. This would have a significant impact on the economics of the process.

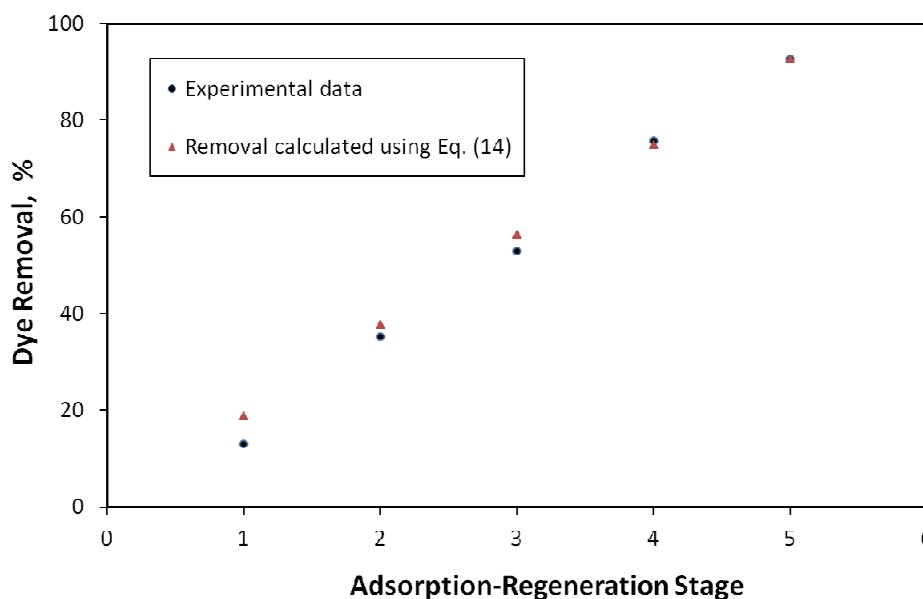

Figure 7. Performance of batch adsorption and electrochemical regeneration for removal of AV17 using the GIC adsorbent NyexTM 1000 with five stages adsorption and regeneration. The initial AV17 concentration was 680 mg L^{-1} and the adsorbent dose was 125 g L^{-1} .

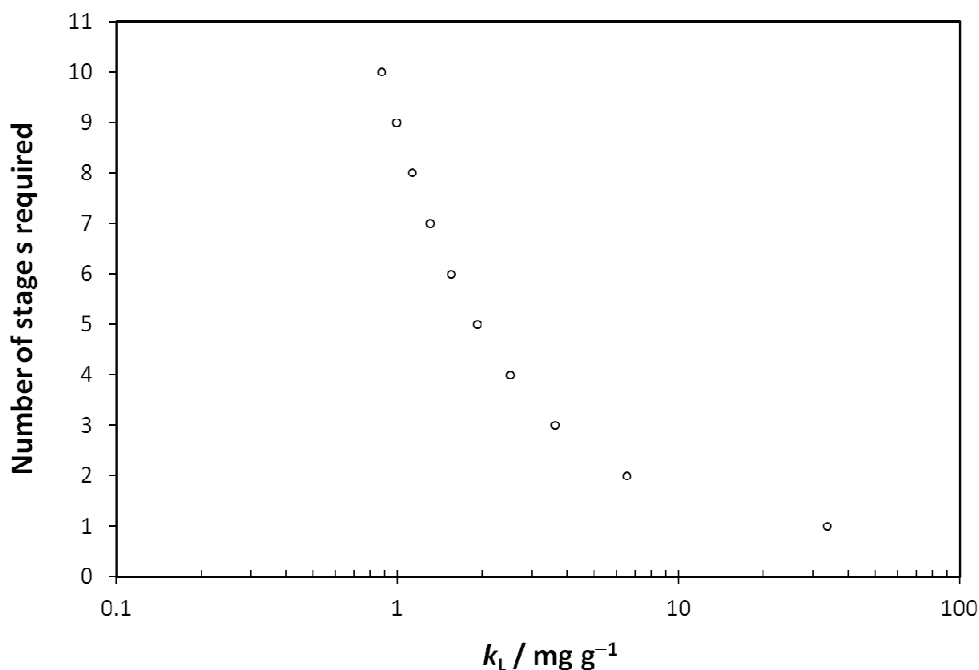

Figure 8. Effect of adsorptive capacity (k_L) on the number of stages required for 99.9% removal of AV17 (with an initial concentration of 1 g L^{-1}) using multi-stage adsorption-regeneration with an adsorbent dose of 125 g L^{-1} .

Conclusions

It has recently been shown that low capacity unexpanded GIC adsorbents can be regenerated rapidly and cheaply, so that they can be regenerated and reused on-site [23,25,26]. This study describes the first detailed study of the adsorption/regeneration characteristics of a graphite intercalation compound. The laboratory scale batch regeneration tests demonstrated that the GIC adsorbent loaded with the organic dye Acid Violet 17 could be fully regenerated with a charge of around 15 C g^{-1} . This charge is of the correct order of magnitude to suggest that the dye was mineralised during regeneration. The energy cost of the regeneration was found to be around 120 J per g of adsorbent regenerated or 115 J per mg of AV17 removed and destroyed.

The effective treatment of wastewater containing a dissolved organic contaminant by multi-stage batch adsorption with electrochemical regeneration has been demonstrated for the first time. Multistage adsorption / regeneration was shown to be effective for the removal of high concentrations of AV17 dye using the GIC adsorbent, exploiting its rapid electrochemical regeneration. Removal of 93 % of the dye from a solution containing 668 mg L^{-1} of AV17 was achieved after five cycles of treatment with 125 g L^{-1} of the GIC adsorbent. A design model for the multi-stage adsorption and electrochemical regeneration process based on the Langmuir equilibrium isotherm has been developed and validated for removal of a dye. This model was used to predict the dose of adsorbent required to achieve a range of dye removals for a given number of adsorption / regeneration cycles. The model was found to be in good agreement with the experimental results obtained for five stages of adsorption / regeneration. It was found that the predicted number of stages of batch adsorption / regeneration required to achieve 99.9 % AV17 removal was halved when the adsorptive capacity of the adsorbent was doubled. This finding confirms that development of adsorbents which can be regenerated electrochemically with increased capacity compared to the GIC used in this study could significantly improve the economics of the process.

Acknowledgements: The authors would like to thank the UK Engineering and Physical Sciences Research Council, ARVIA Technology Ltd and the Iraqi Ministry of Higher Education and Scientific Research for their financial support for this research.

References

- [1] P.A. Pekakis, N.P. Xekoukoulotakis, D. Mantzavinos, *Water Res.* **40** (2006) 1276-1286.
- [2] J. Mo, J.-E Hwang, J. Jegal, J. Kim, *Dyes Pigments* **72** (2007) 240-245.
- [3] P. Nigam, G. Armour, I.M. Banat, D. Singh, R. Marchant, *Bioresource Technol.* **72** (2000) 219-226.
- [4] S.B. Wang, Y. Boyjoo, A. Choueib, Z.H. Zhu, *Water Res.* **39** (2005) 129-138.
- [5] G. San Miguel, S.D. Lambert, N.J.D. Graham, *Water Res.* **35** (2001) 2740-2748.
- [6] N. Kannan, M.M. Sundaram, *Dyes Pigments* **51** (2001) 25-40.
- [7] Y. Guo, S. Yang, W. Fu, J. Qi, R. Li, Z. Wang, H. Xu, *Dyes Pigments* **56** (2003) 219-229.
- [8] C. Namasivayam, M. Dinesh Kumar, K. Selvi, R. Ashruffunissa Begum, T. Vanathi, R.T. Yamuna, *Biomass Bioenerg.* **21** (2001) 477-483.
- [9] C. Namasivayam, D. Kavitha, *Dyes Pigments* **54** (2002) 47-58.
- [10] G. McKay, M. El Geundi, M.M. Nassar, *Water Res.* **21** (1987) 1513-1520.
- [11] M. Özacar, I.A. Sengil, *J. Hazard. Mater.* **98** (2003) 211-224.
- [12] G. Annadurai, R.-S. Juang, D.-J. Lee, *J. Hazard. Mater.* **92** (2002) 263-274.
- [13] G.S. Gupta, G. Prasad, V.N. Singh, *Water Res.* **24** (1990) 45-50.
- [14] R. Sivaraj, C. Namasivayam, K. Kadirvelu, *Waste Manage.* **21** (2001) 105-110.
- [15] R.A. Shawabkeh, M.F. Tutunji, *Appl. Clay Sci.* **24** (2003) 111-120.
- [16] N. Thinakaran, P. Baskaralingam, M. Pulikesi, P. Panneerselvam, S. Sivanesan, *J. Hazard. Mater.* **151** (2008) 316-322.
- [17] R.M. Narbaitz, J.Q. Cen, *Water Res.* **28** (1994) 1771-1778.
- [18] P. Canizares, J. Lobato, J. Garcia-Gomez, M.A. Rodrigo, *J. Appl. Electrochem.* **34** (2004) 111-117.
- [19] R.M. Narbaitz, A. Karimi-Jashni, *Environ. Technol.* **30** (2009) 27-36.
- [20] R. Berenguer, J.P. Marco-Lozar, C. Quijada, D. Cazorla-Amoros, E. Morallon, *Carbon* **48** (2010) 2734-2745.
- [21] N.W. Brown, E.P.L. Roberts, A. Chasiotis, T. Cherdron, N. Sanghrajka, *Water Res.* **38** (2004) 3067-3074.
- [22] N.W. Brown, E.P.L. Roberts, A.A. Garforth, R.A.W. Dryfe, *Electrochim. Acta* **49** (2004) 3269-3281.
- [23] N.W. Brown, E.P.L. Roberts, A.A. Garforth, R.A.W. Dryfe, *Water Sci. Technol.* **49** (2004) 219-225.
- [24] N.W. Brown, Adsorption and electrochemical regeneration for wastewater treatment: development of a process, PhD Thesis, UMIST, Manchester, UK, 2005.
- [25] N.W. Brown, D.A. Wickenden, E.P.L. Roberts, *Waste Management Symposium, Proceedings of WM2012, Phoenix, Arizona, USA, 2012.*
- [26] F.M. Mohammed, E.P.L. Roberts, A. Hill, A.K. Campen, N.W. Brown, *Water Res.* **45** (2011) 3065-3074.
- [27] S. Ismadji, S.K. Bhatia, *Can. J. Chem. Eng.* **78** (2000) 892-901.
- [28] E.N. El Qada, S.J. Allen, G.M. Walker, *Chem. Eng. J.* **135** (2008) 174-184.
- [29] F.M. Mohammed, Modelling and design of water treatment processes using adsorption and electrochemical regeneration, PhD Thesis, University of Manchester, Manchester UK, 2011.
- [30] M. Gordon, *J. Chem. Technol. Biot.* **32** (1982) 759-772.
- [31] G. McKay, M.S. Otterburn, J.A. Aga, *Water Air Soil Poll.* **24** (1985) 307-322.

- [32] M. Dogan, M. Alkan, Y. Onganer, *Water Air Soil Poll.* **120** (2000) 229-248.
- [33] M. Özacar, I.A. Sengil, *Environ. Geol.* **45** (2004) 762-768.
- [34] M. Özacar, I.A. Sengil, *Biochem. Eng. J.* **21** (2004) 39-45.
- [35] V. Vadivelan, K.V. Kumar, K. V. *J. Colloid Interf. Sci.* **286** (2005) 90-100.
- [36] E.I. Unuabonah, K.O. Adebawale, A.E. Ofomaja, *Water Air Soil Poll.* **200** (2009) 133-145.
- [37] H.M.A. Asghar, Development of graphitic adsorbents for water treatment using adsorption and electrochemical regeneration, PhD Thesis, University of Manchester, Manchester, UK, 2011.
- [38] H.M.A. Asghar, E.P.L. Roberts, S.N. Hussain, A.K. Campen, N.W. Brown, Submitted to *J. Appl. Electrochem.* (2012).